



赫兹电力
HERTZ POWER



赫兹电力
HERTZ POWER

产品宗旨：技术领先，质量可靠，服务周到，客户至上。
服务宗旨：快速响应，达到满意，超过期望。

赫兹电力
HERTZ POWER





HZSP

1 1

HZSP

GB/T 17623-1998

GB/T 7252-2001

CO CO₂

TCD H₂ O₂(N₂) FID

i



赫兹电力
HERTZ POWER

产品宗旨：技术创新，质量可靠，服务周到
服务宗旨：快速响应，达到满意，超过期望



FID TCD

24 AD

1 3 HZSP
HZSP

1 3 1
HZSP



赫兹电
HERTZ POWER

产品宗旨：技术创新，质量第一，服务宗旨：快速响应，达到客户要求，超过期望



1.5 HZSP

128*64

6

4

450

1

s

p



$5 \times 10^{14}A$

$1 \times 10^{13}A/30mi n$

10^6

450

TCD

S 4000mV·ml /mg() 1 2 4 8

$10\mu V$

$30\mu v/30mi n$

1 4 HZSP

1 4 1

HZSP

1 4 2

HZSP

1. 7

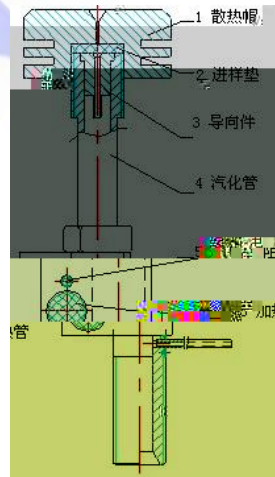

1. 7 HZSP

1. HZSP



2. HZSP

5mm

3 4mm

1 4 3

TCD

HZSP

TCD

1.9

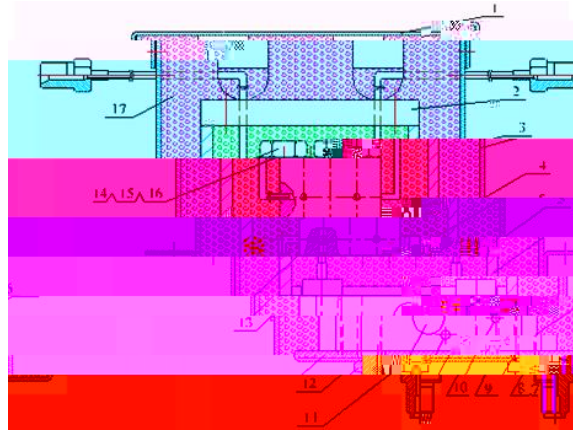

α) Δ, η (λ) 1

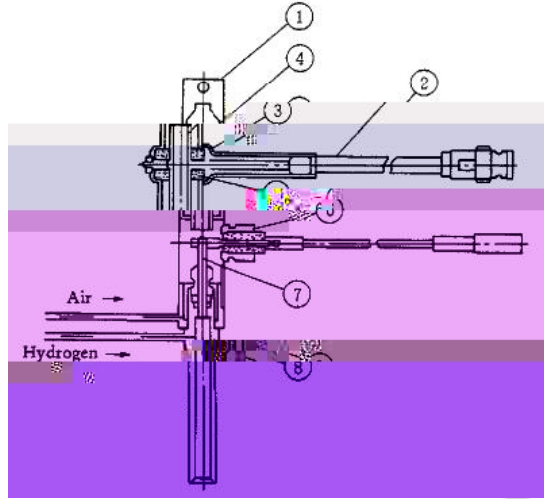

1 2 3 4 5 6 7 8
1.10 FID
FID
FID
FID

1





赫兹电力
HERTZ POWER



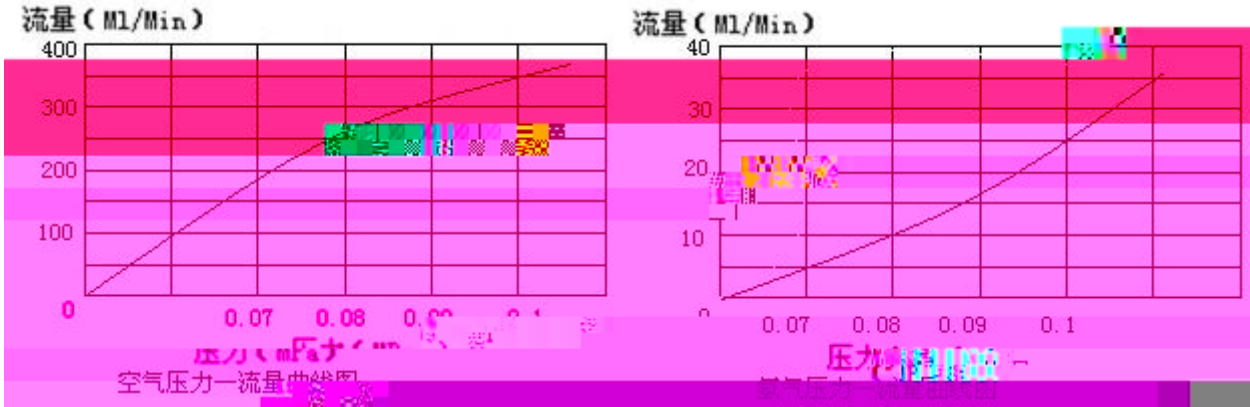

1 4 7

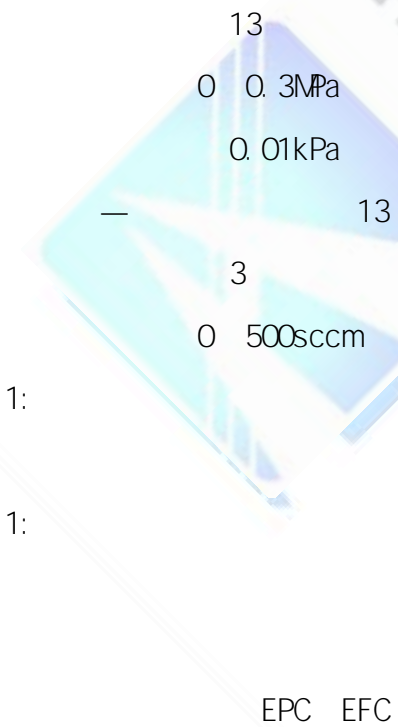

EPC EFC



1 4 12 HZSP

RS232

2

5000

CAN

MODBUS

GPRS

3G

10/100M

5

-2.5V 2.5V

0.05μ V·s

225

027-83267669



noe
% ⇒ w mV μ V
10⁻⁷
± 0.005%
± 0.005%
20 /

1 5

1 5 1

HZSP

5 35 0 85%

HZSP

HZSP

30cm

30—40cm

HZSP

10/100M

HUB

1 5 2

m

v

HZSP

220V± 10% 50Hz± 0.5 Hz

2000W

HZSP

r

r

000M

U06

Q F C

2 1

è

赫兹电力
服务宗旨：快速响应，达到，超过

2 2

“ ”

È è

赫兹电力
HERTZ POWER

E

S

R

2 2 3

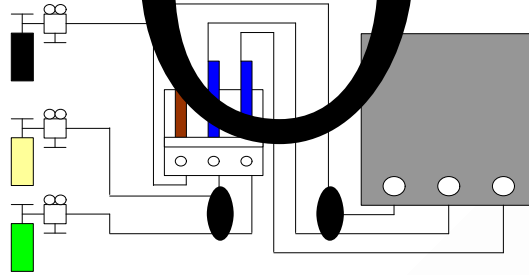

2 1



赫兹电力
HERTZ POWER

1.

2.



赫兹电力
HERTZ POWER



赫兹电力
HERTZ POWER



" C:\NetChrom\ "

" "

" "

" "

" "

" "

" "

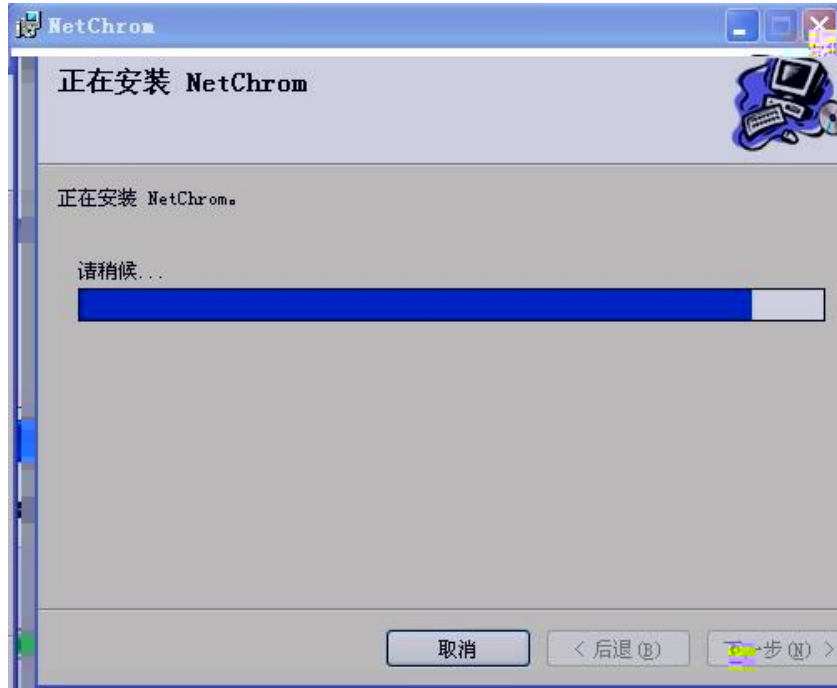

" "

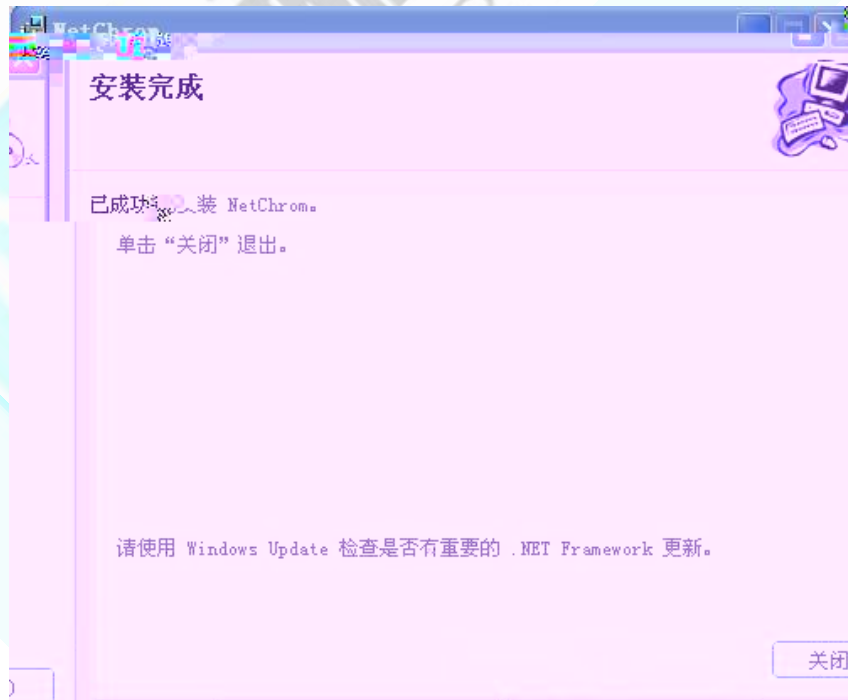

" "

"

"

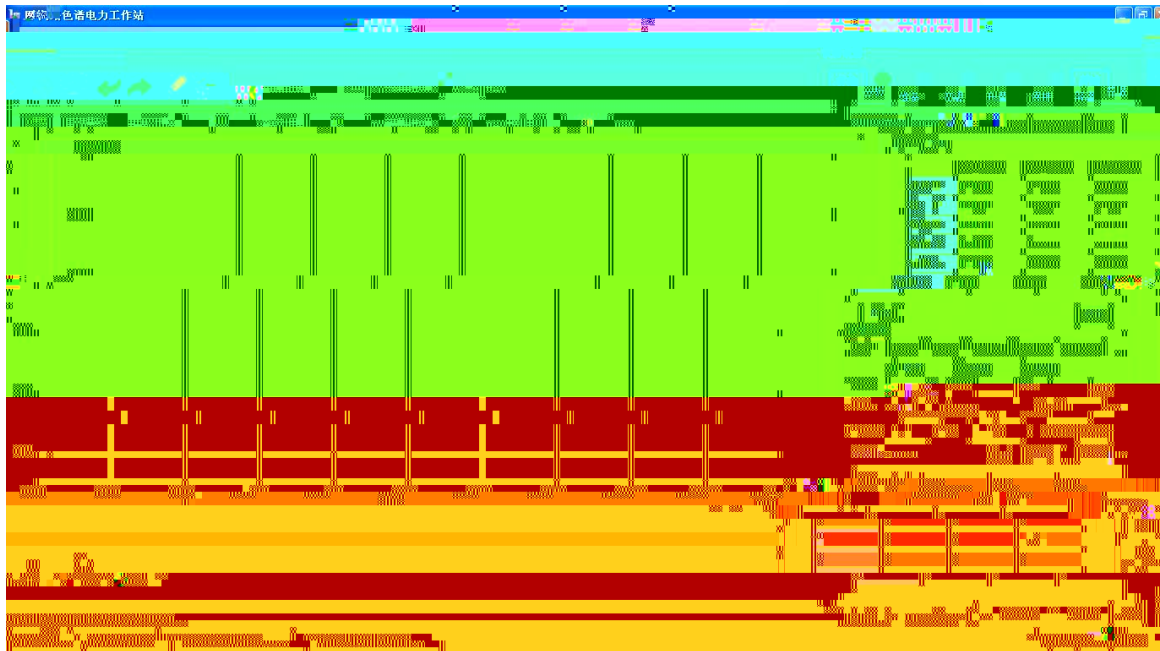

“ CDMC ”

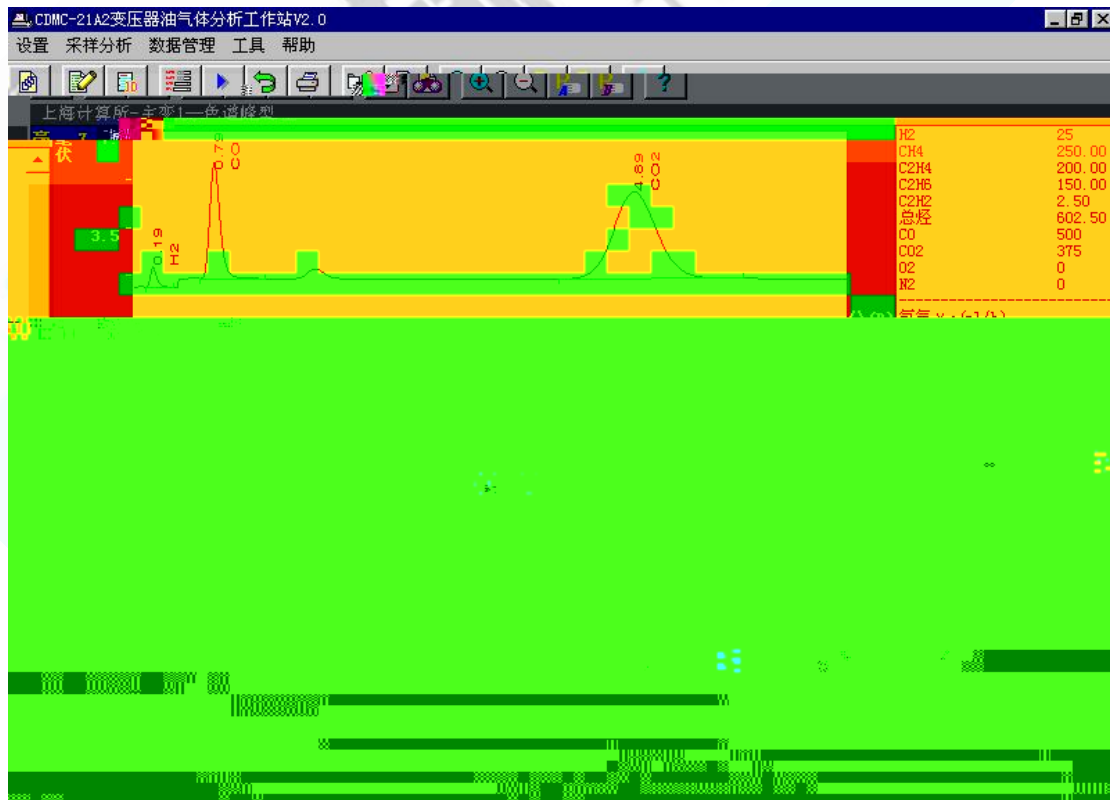

2 4

IP IP IP IP

" DHCP" " DHCP" IP IP

2 4 1 " " " " IP

IP IP

" " " " " " " Internet TCP/IP "

" " " " " " " " " " "

" Internet TCP/IP "

" IP S " " IP | " " " " "

" " IP " 192.168.0.2"





赫兹电力
HERTZ POWER

NOTICE



赫兹电力
HERTZ POWER



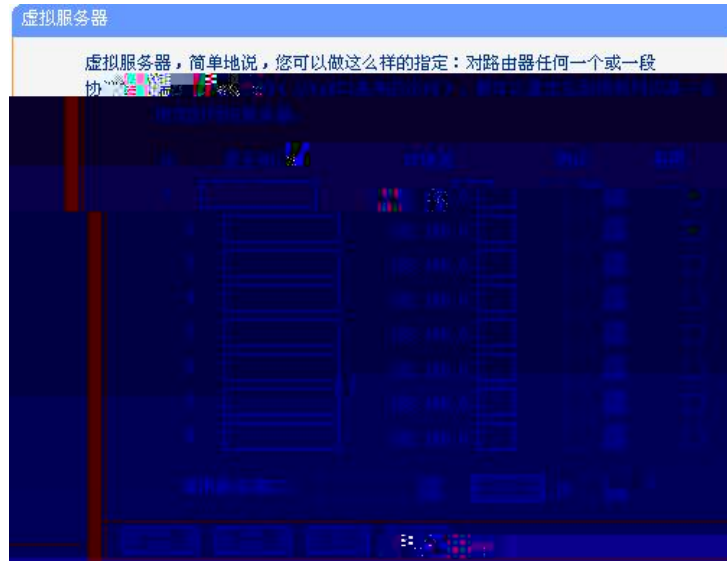

IP
" 192.168.0.2"

IP

IP

IP

IP

2 4 4

"

"

ID

" HZSP

" HZSP

"

HZSP

3 1

HZSP

128*64

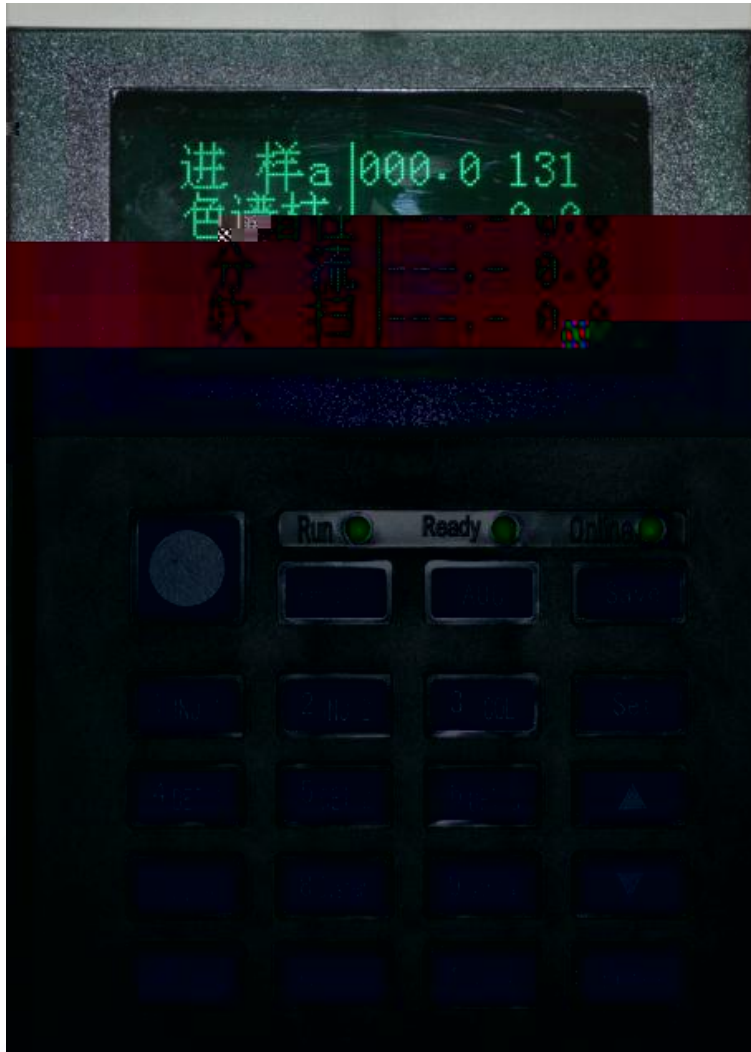

HZSP

HZSP

20

3



Stop

ACC

Save



Set



Enter

12

" DEL" " ."

RUN

Ready

± 1

± 6

Online

config

Set

EPC

5

450

HZSP

29

3 1 1

A

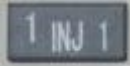

A

a	120.0	120
	001.2	1.2
	030.0	030
	002.0	2.0

1

A



b

	120.0	120
b	001.2	kPa
	001.5	m /
	30	

" 3.1.1

A

"

a b

a b

3 1 4

a



a

a

"

赫兹电力
HERTZ POWER





8

" 3.1.1 A "

0

1

0

START

START

00.00

NO. 01

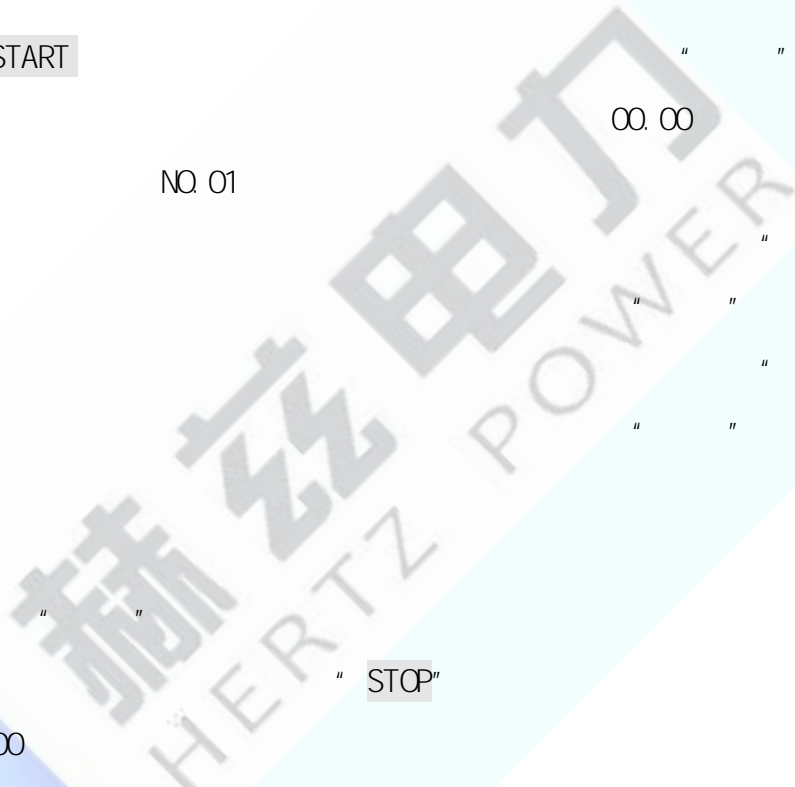

± 1

" STOP "

00.00

3 1 7

4 DET 1

5 DET 2

6 DET 3

a b c

a	120.0	120
	030.2	030
	300.0	300
	022.0	022

a	120.0	120
	030.2	030
	300.0	300
	022.0	022

a 120.0 120
030.2 030
300.0 300

赫兹电力
HERTZ POWER

Enter

" "

" " " "

" 3.1.1

A

"

赫兹电力
HERTZ POWER

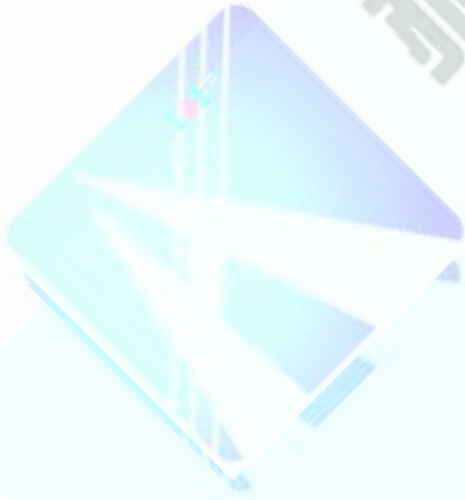



9999

: 008. 0mi n"

0

08.



赫兹电力
HERTZ POWER



:0

3 1 11

IP

ID

3 1 11 1

8 System

0002
0001
7
99min
14/03/08
12:00

" 3.1.1 A "

0-7

" " / / : :

99

5

FID 10-20uV

99



3 1 11 2



A:
B:
:

A:
B:
:

" 3.1.1 A "

" " DEL

3 1 11 3



⋮
⋮
⋮

" 3.1.1 A "

" " DEL



产品系列 服务支持 快速响应, 达 意, 超过

3 1 11 4 IP



IP
192.168.018.220
255.255.255.000
192.168.018.001

IP
192.168.018.200
192.168.018.199
192.168.018.198

"

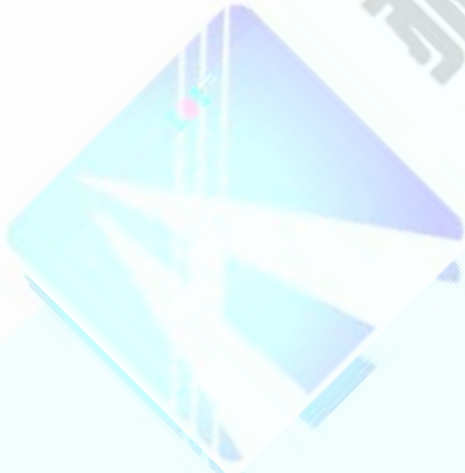

赫兹电力
HERTZ POWER

m

~
m

IP

IP

" "

IP

IP

IP

" " <--->

IP

IP

IP

IP

IP

"

IP

"

IP

IP

IP

" IP "

3 1 11 5

ID



ID

0	0
	2sVer
A14. 03. 08. 01	

10

0-9

0

1

FID FPD

3 1 11 6



225

027-83267669



产品种类多，服务周到，响应迅速，达到满意，超过...

33

50mi
00. 0
00. 00
DEL STW

HZSP	000. 00		
GyAÑ	H 3	,	n

赫兹电力
HERTZ POWER



赫兹电力
HERTZ POWER



3 1 14 FID

FID

FID

FID



SET

"

"

150

赫兹电力
HERTZ POWER

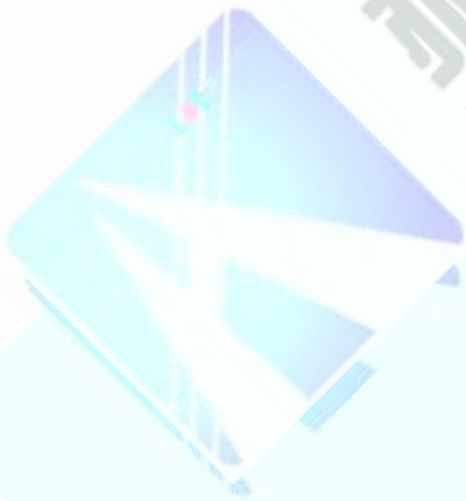

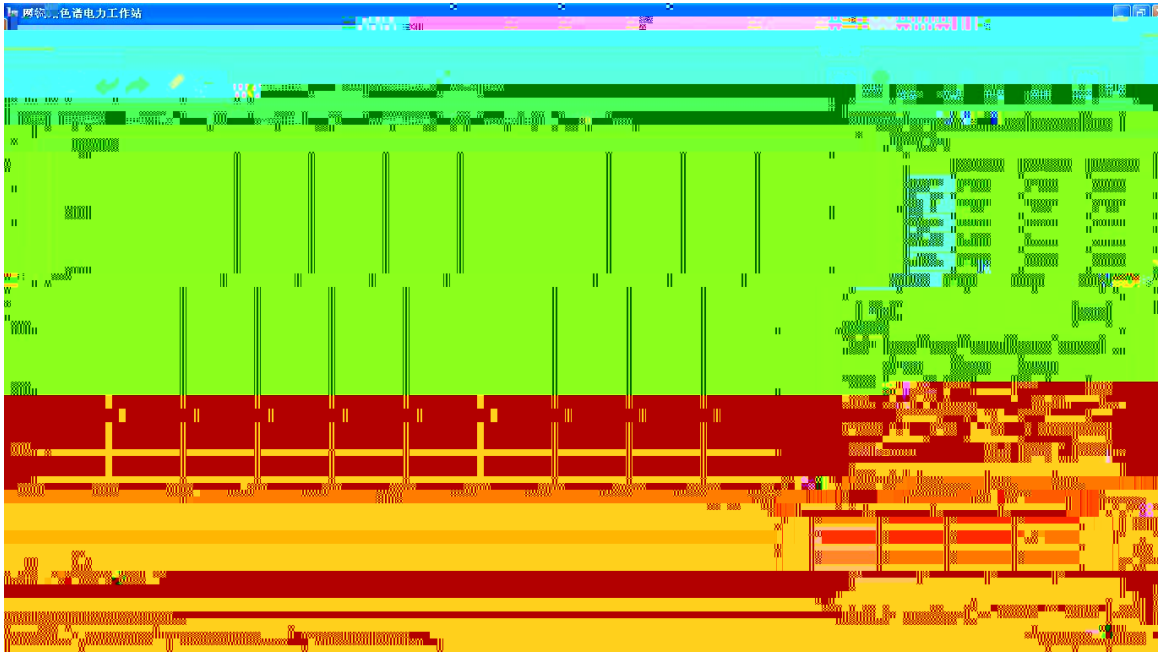

4 2

4 2 1 (F)

4 2 1 1

" "



" "

4 2 2 S

4 2 2 1

" "

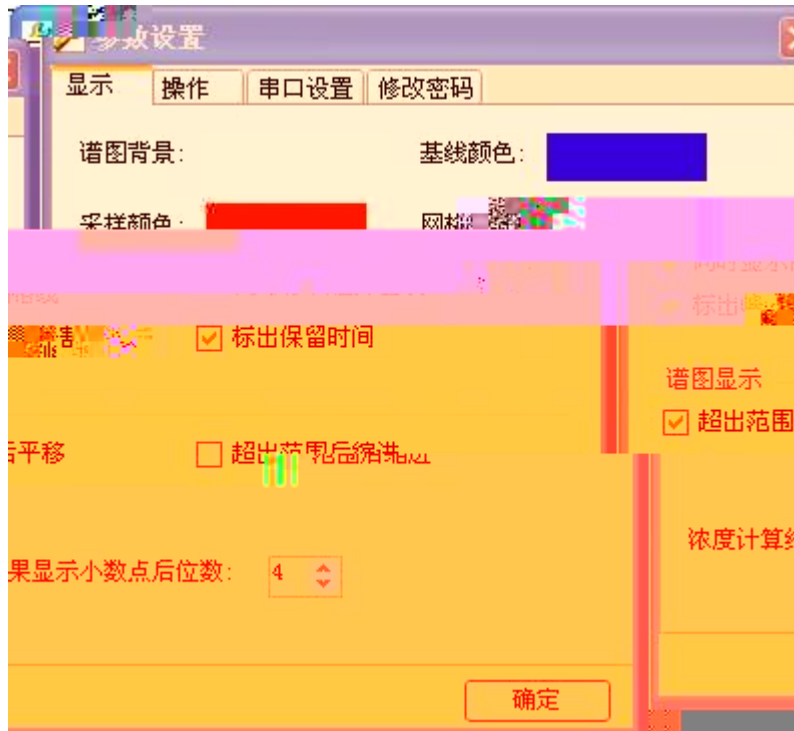



C



COM

GC



" n "





4 2 2 3

名称	中文	英文	使能
控区一	进样器	INJ	<input checked="" type="checkbox"/>
控区二	柱 炉	COL	<input checked="" type="checkbox"/>
控区三	检测器	DET	<input checked="" type="checkbox"/>
控区四			
控区五			

4 2 2 4

" "

1 TCD

2

A

B

3

2

3

2 FID

3

2

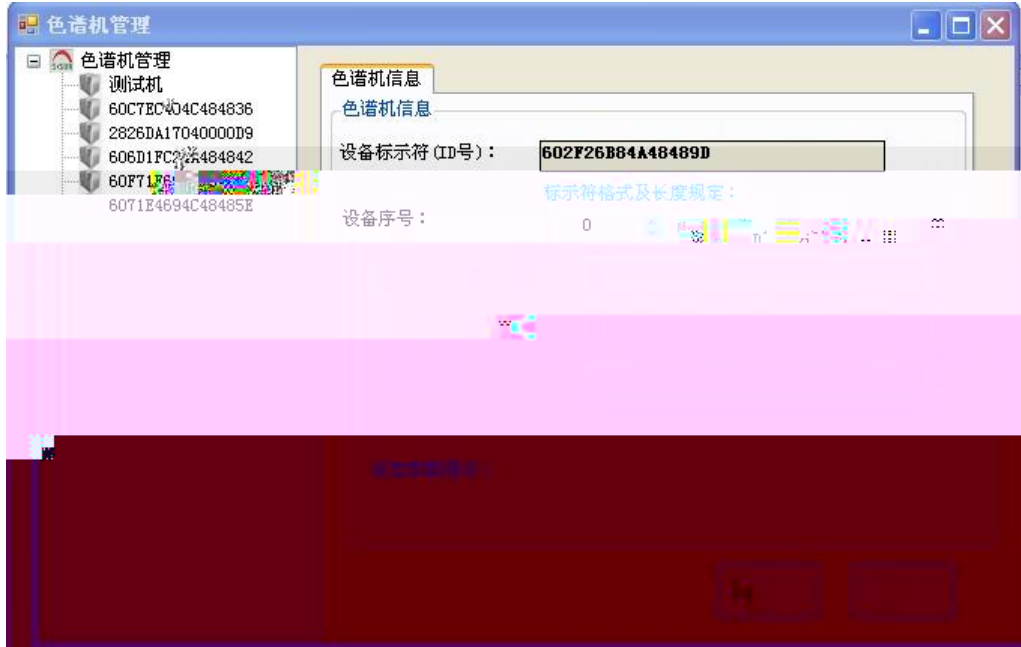

4 4 1

ID

ID

ID

3 1 8

"

"

1

1

1_FI D1_2008 12

01 _8 58 58 .SDA

4 4 5

" "

4 5

赫兹电力
HERTZ POWER

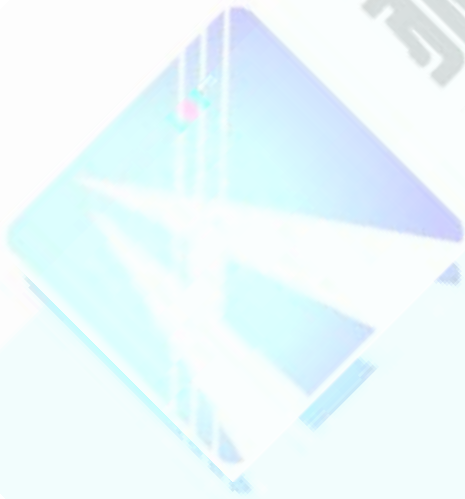

ë

E

■ ■

5 ž / ä R C

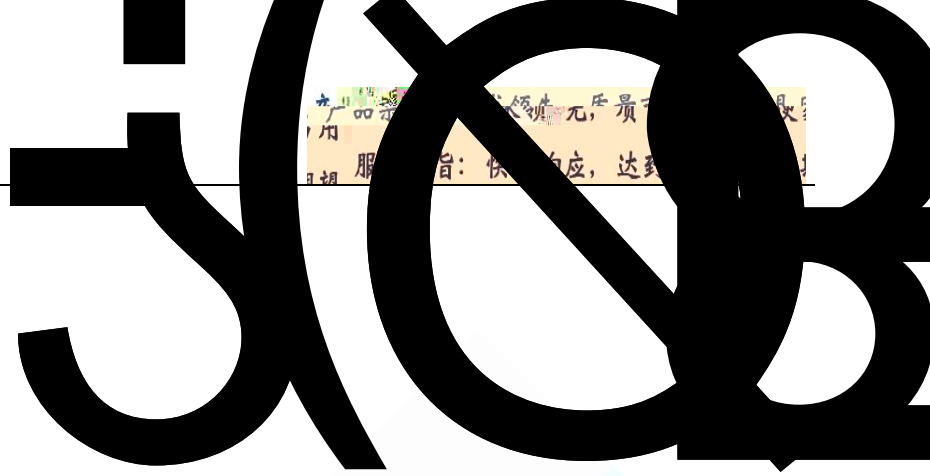

产品... 服务... 响应... 达到...

4 5 7

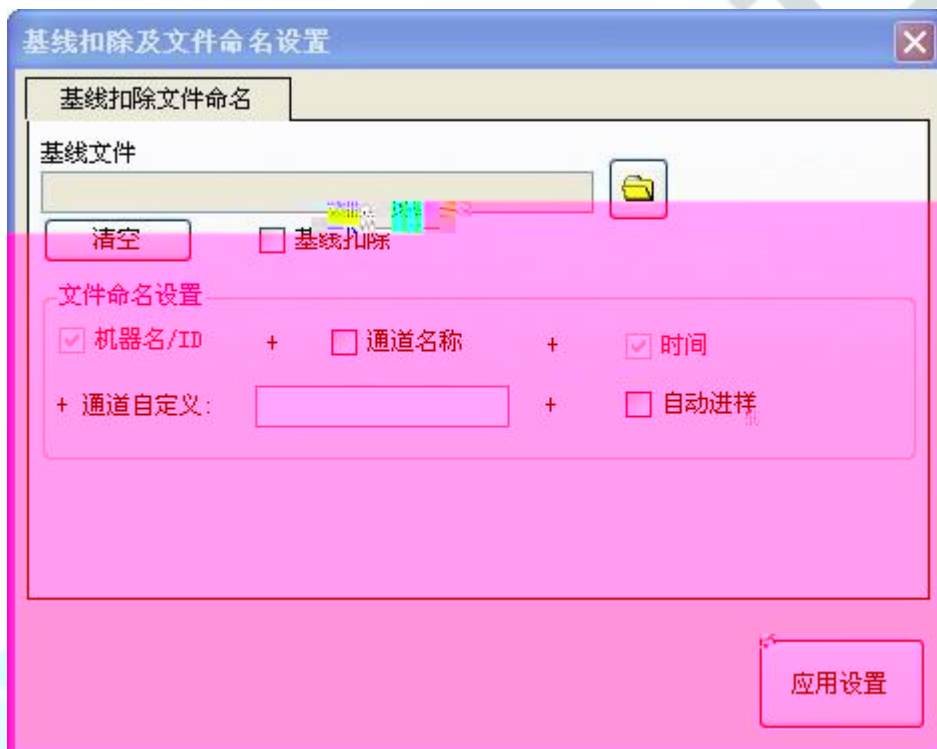

FI D1 TCD2





4 5 11

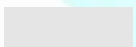

0

1

4 5 12

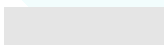

4 5 13



4 5 14

4.5 4.6

4 6

4 6 1



6



流量控制

进样1 进样2 进样3 检测器1 检测器2 检测器3

载气 分流 吹扫

输入: [] KPa 输出: [] KPa [] sccm

模式: 压力 流量 流量 [0] sccm

色谱柱: 0.1 [] 0.045 m 气体: 氮气

分流比: * : 1 关 [查询] [设定]

1

EFC

EFC

EFC

225

027-83267669



赫兹电力
HERTZ POWER

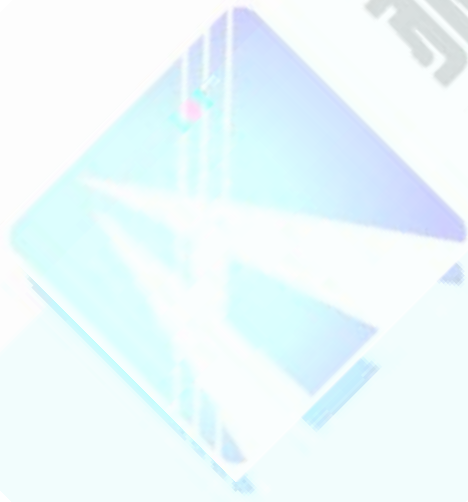

赫兹电力
HERTZ POWER



温度/流量 程升/事件 进样器 网络/断水 消息

程升控制 初始时间:

阶号	升温速率	保持温度	保持时间
1	0	200	0
2	0	0	0
3	0	0	0
4	0	0	0
5	0	0	0
6	0	0	0
7	0	0	0
8	0	0	0
9	0	0	0

事件控制

阶号	事件1 [min]	事件2 [min]	事件3 [min]	事件4 [min]
1		1.4	0	0

查询 设定



" "



4 6 4

" "

AOC-20i

" " " "



" " " " " " " " "

1

3

2
10

3

225

027-83267669



4 6 5

" / "

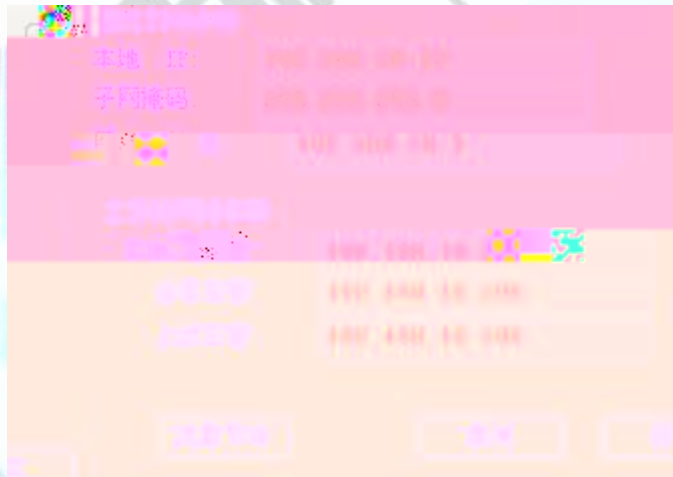

" "

" 3 1 8

" " 2 4 1

"

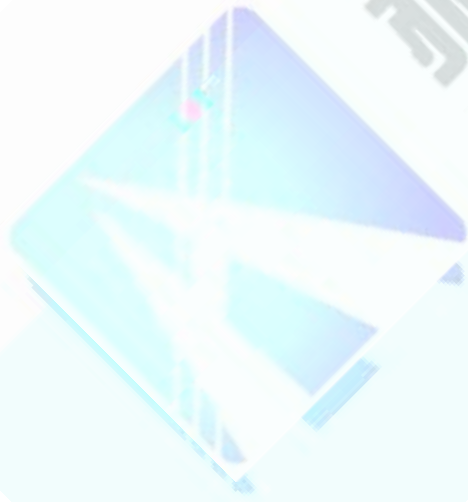

赫兹电力
HERTZ POWER

HERTZ

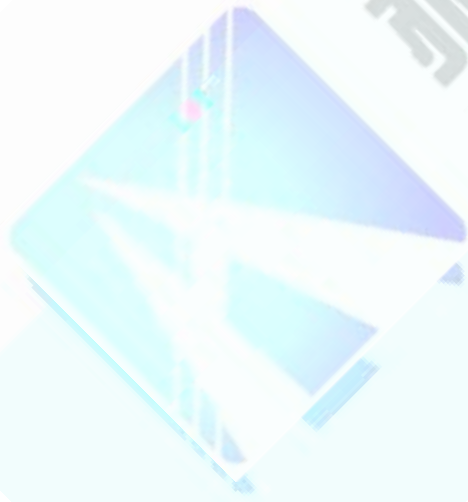

赫兹电力
HERTZ POWER



赫兹电力
HERTZ POWER

产品宗旨：技术创新，品质可靠，服务宗旨：快速响应，排忧解难



m

赫兹电力
HERTZ POWER

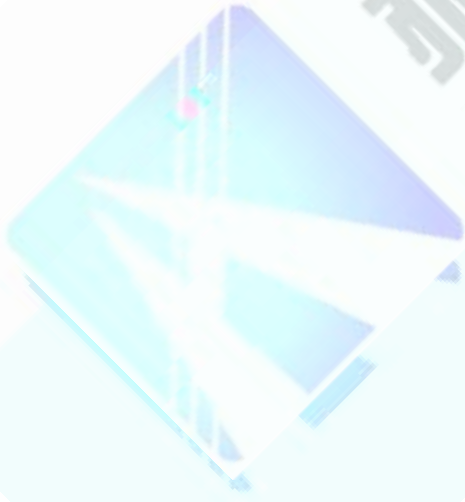



5 2

- W N9X
- W NDCMS
- 0. 006
-
-
-
-
-
-
-

5 3

5 3 1

Penti um II 233
 32M
 SVGA 800× 600
 CD-ROM
 Microsoft Windows 98/Me/NT/2000/XP

5 3 2

Windows



TD

CDM



" "

" "

" "

" "

“ ”

“ ” “ ” “ ”

CDMC-21

5



" / "

" CDMC-21 V3.0" " / "

5 3 3



赫兹电力
HERTZ POWER

COM

5 4 3

5 4 4



赫兹电力
HERTZ POWER

CDMC-21

h



赫兹电力
HERTZ POWER

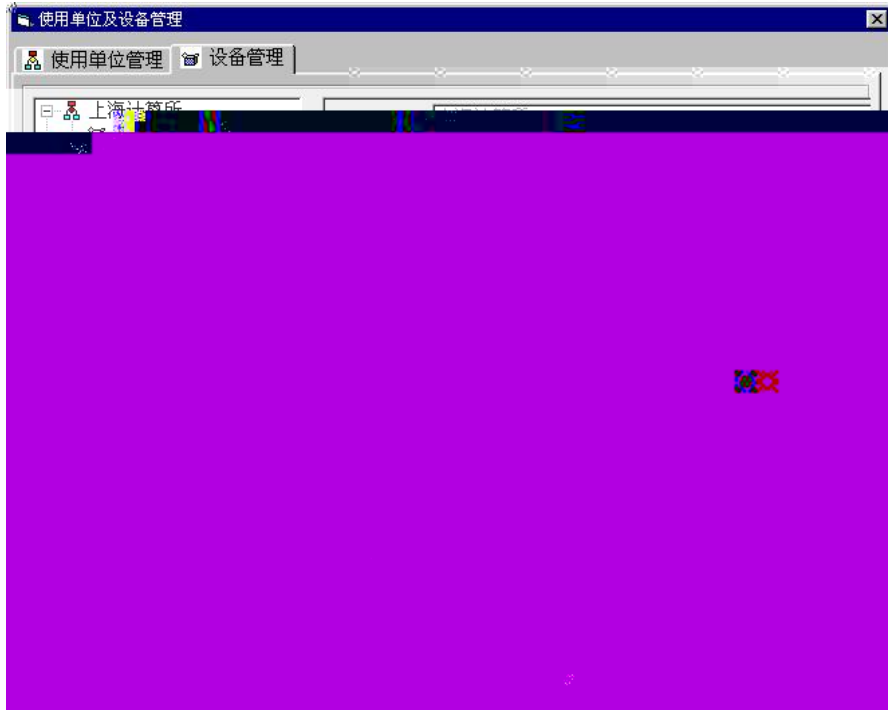



赫兹电力
HERTZ POWER

产品宗旨：技术领先，质量可靠，服务周到，客户至上。
服务宗旨：快速响应，达到满意，超过期望。

赫兹电力
HERTZ POWER



ID " "

ID 6 ID

(4) ID

" ID " " " → " → ID " " A/B"

" A" " "

" " " B" A

B

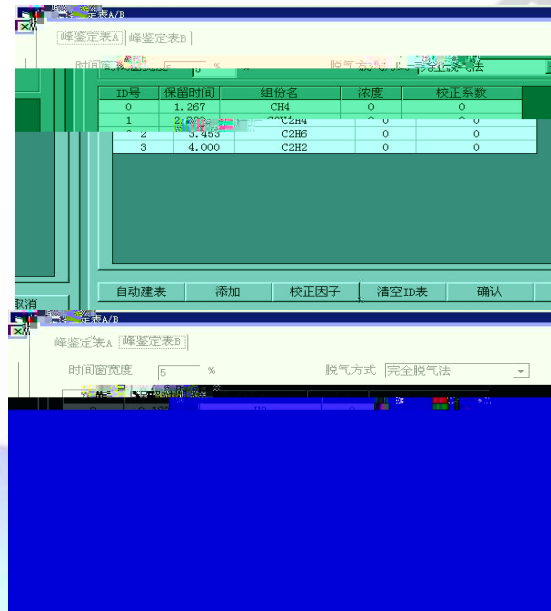

(5)

" " " " " "

" "

(6)

" " " " "

" "

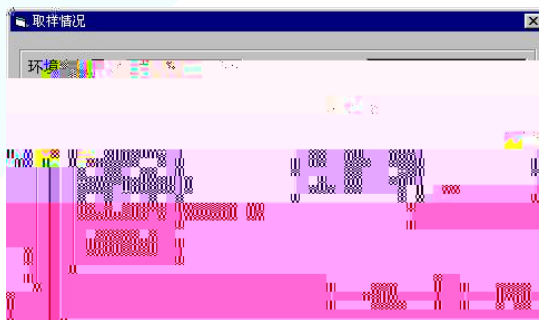



赫兹电力
HERTZ POWER

产品宗旨：技术领先，质量可靠，服务周到，客户至上。
服务宗旨：快速响应，达到满意，超过期望。

赫兹电力
HERTZ POWER



~+1000mv

1mv

3.

A

" " " "

5 5 2

1.

" → → " "



" → → "

A B



2.

ID

ID

ID

ID

ID

3.

ID

→ ID

A/B"

A B

A

A

B

B



" " ID

" " ID ID

" ID " ID

ID

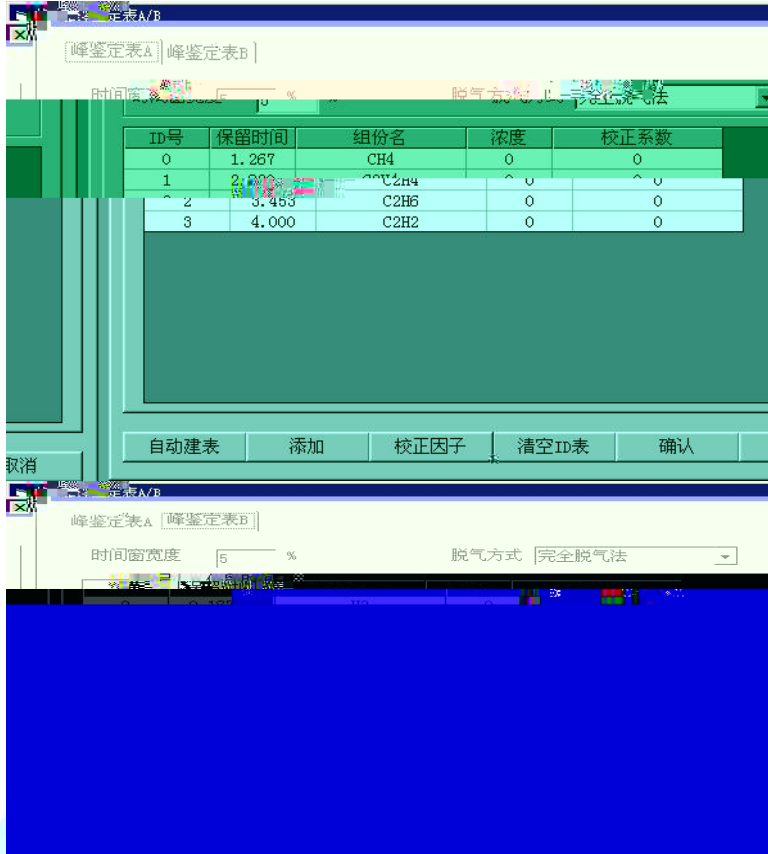

4.

" " → "

" Ctrl "

" "

ID

" "

" "

氢气	一氧化碳	二氧化碳	甲烷	乙烯	乙烷	乙炔	氧气
0.00052	0.01438	0.02203	0.00000	0.00003	0.00044	0.00014	
0.00052	0.01438	0.02203	0.00000	0.00003	0.00044	0.00014	0.00000
0.00052	0.01438	0.02203	0.00000	0.00003	0.00044	0.00014	0.00000

赫兹电力
HERTZ POWER

7.



(1)

" "

0

1

2

(2)

" m



赫兹电力
HERTZ POWER



赫兹电力
HERTZ POWER

INC

白·山... 元... 快速响... 达到满意...

" "

10.

赫兹电力
HERTZ POWER

" " → "





5 6 3

" " → " "

" → " "

" Delete"

" "

" → "

5 6 4

< r

" → "

"

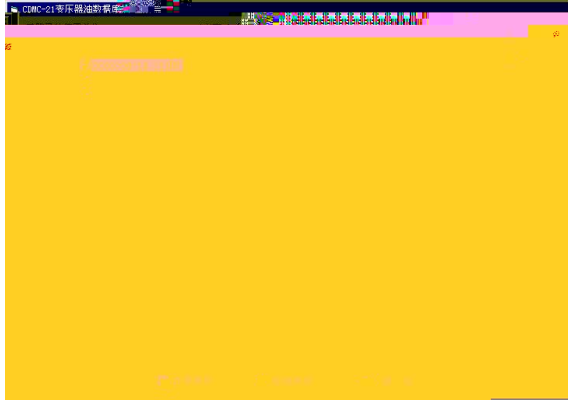

“ ”

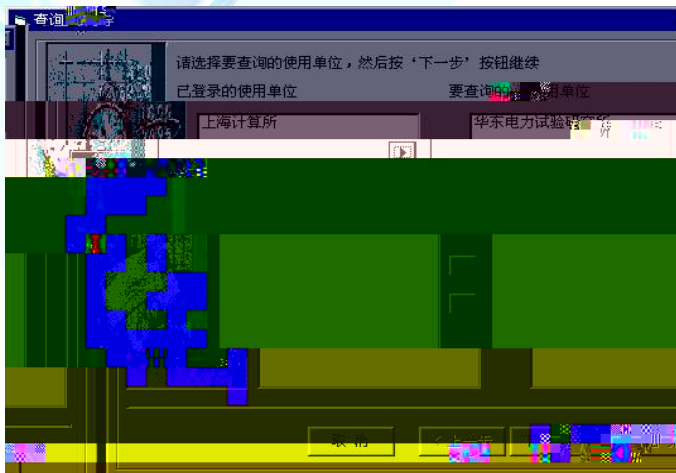
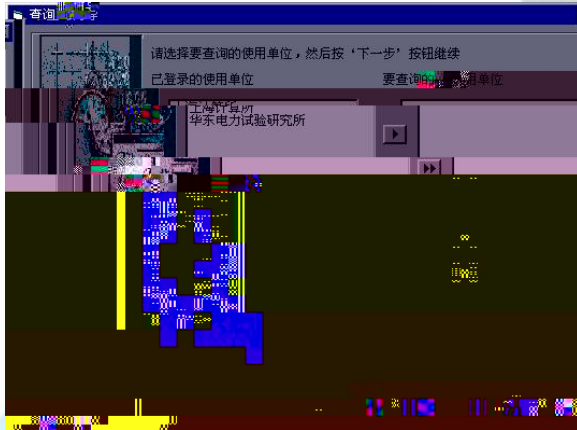



赫兹电力
HERTZ POWER

产品宗旨：技术创新，质量可靠，服务周到
服务宗旨：快速响应，达到满意，超过期望

“ ”

“ ”



赫兹电力
HERTZ POWER

A



5 6 8

“ ” “ ” “ ” “ ”

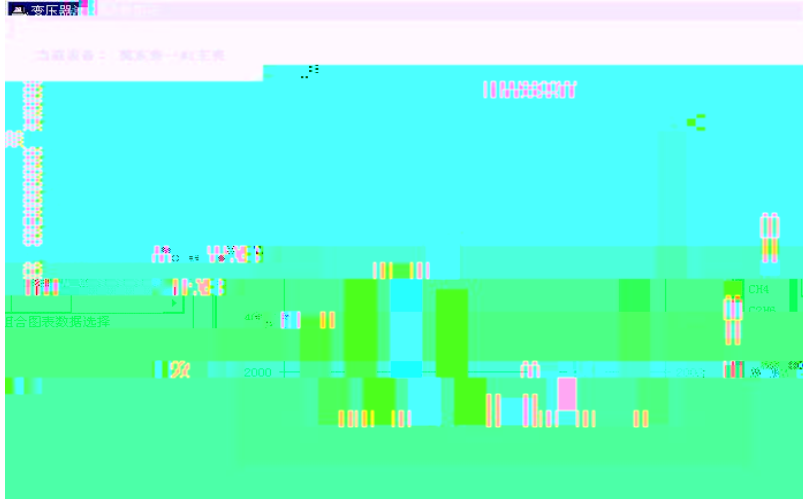

● “ ”

●

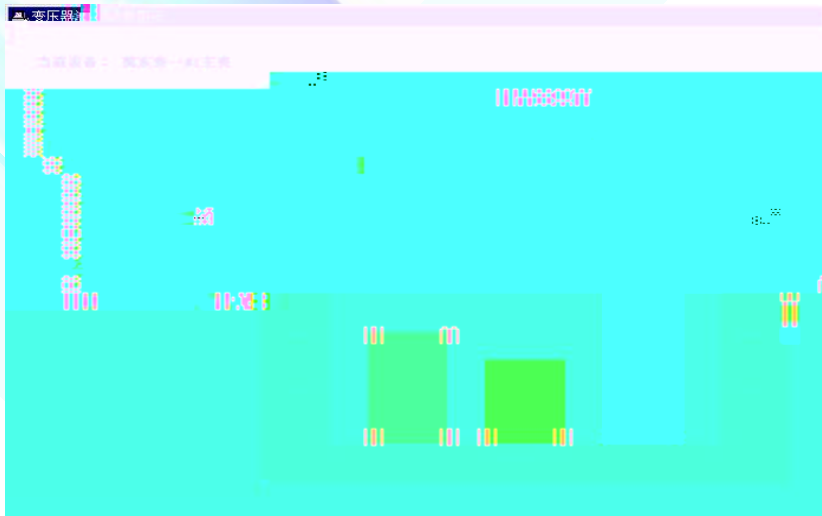



“ ”

“ ”

H2



赫兹电力
HERTZ POWER

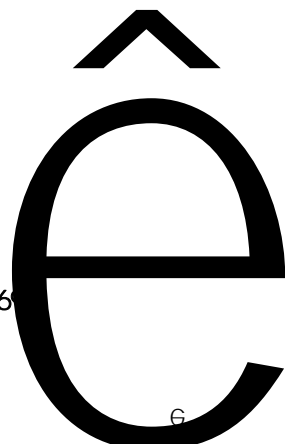
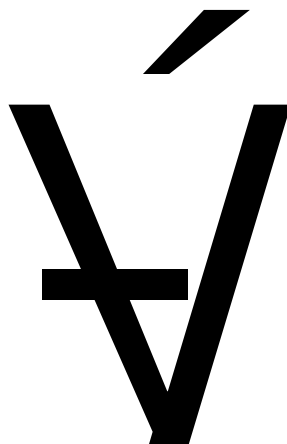



赫兹电力
HERTZ POWER



赫兹电力
HERTZ POWER

产品宗旨：技术领先，质量可靠，服务周到
服务宗旨：快速响应，达到满意，超过期望

OMM

赫兹电力
HERTZ POWER



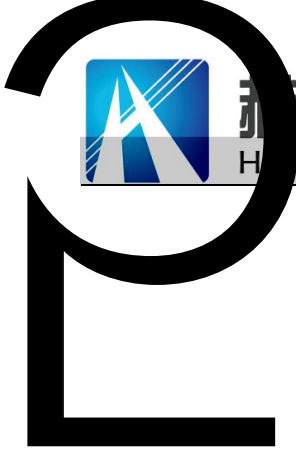

5.1.6

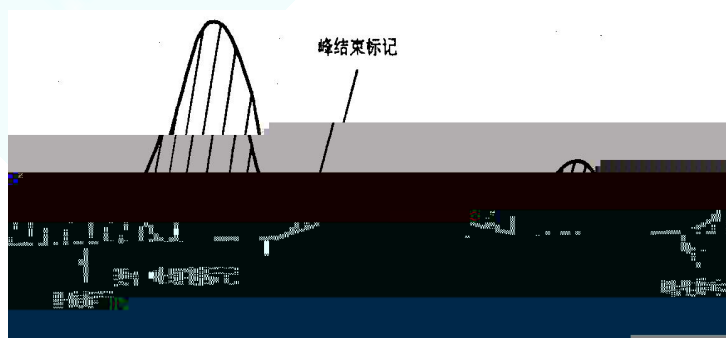
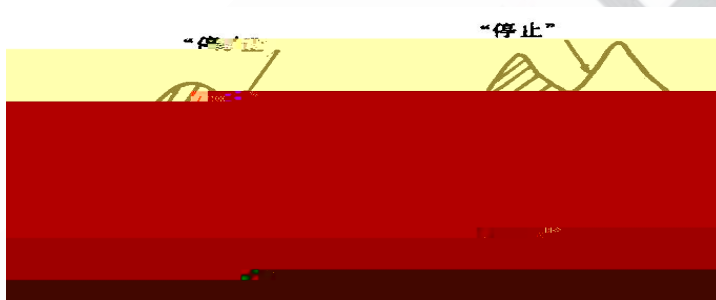

2

" I "

" N "

" T "

" MM "

" B "

" V "

" B "

" V "

" T "

3

CDMC- 21

()

CDMC- 21

()

4

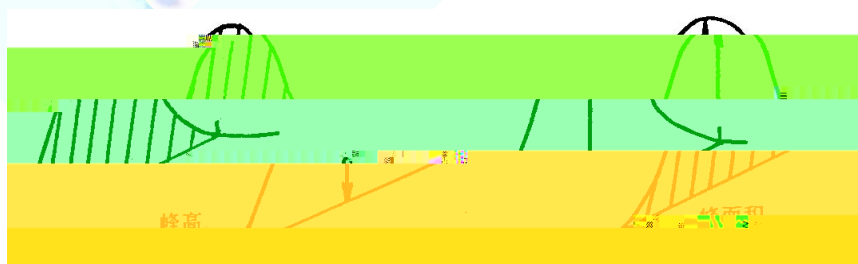

CDMC-21

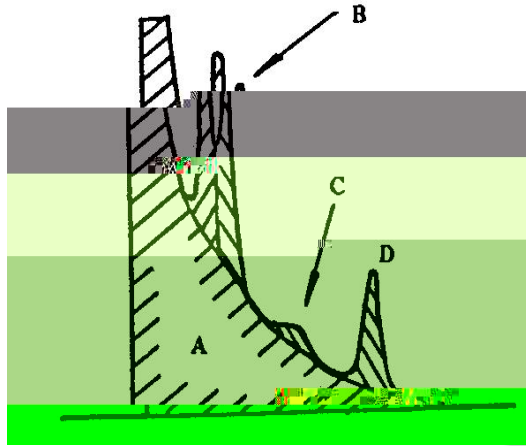

2

B

C

D

A

CDMC-21

5. 2. 4. 2

CDMC-21

5 7 3

ID

ID



%

ID

ID

IS

TIME WINDOW

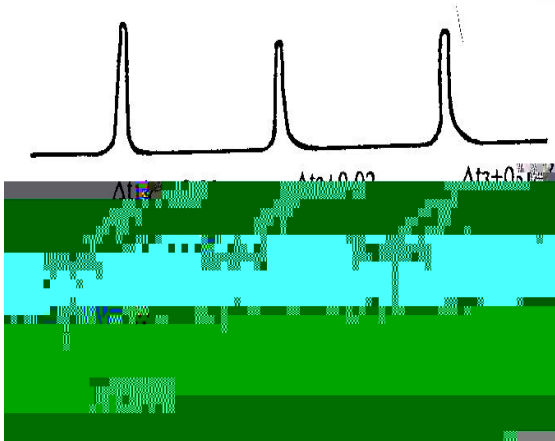

* % +0.02

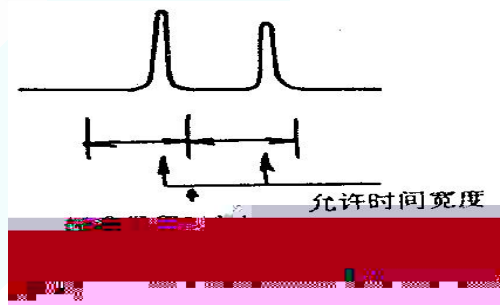

2

2

ID

(a) , ID

(b)

B

ID

1

2

B

1

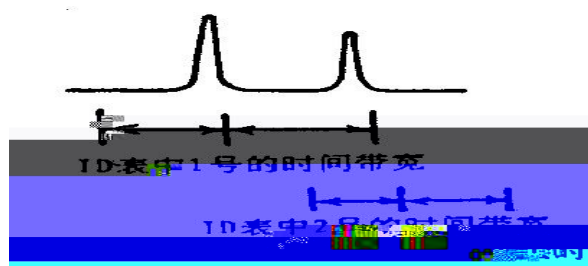

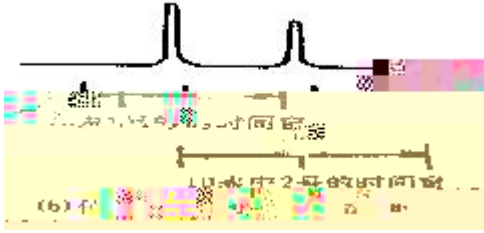

ID

B ID 1 2

2

B ID

2

5 7 4

赫兹电力
HERTZ POWER

0.01

0.00

10

10

1 " "

2 " "

3 " "

4 " "

5 " "

6 " "

ON OFF





7 " "

ON OFF

ON OFF



8 " "

ON OFF

ON OFF

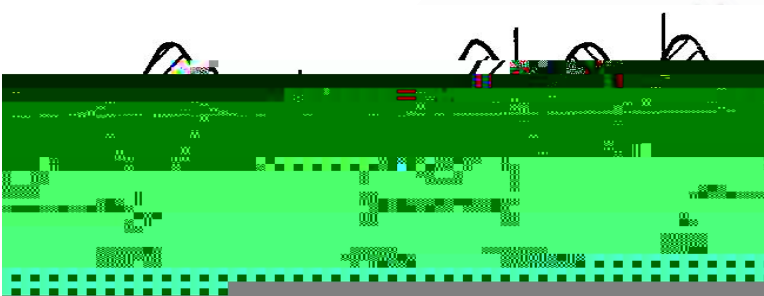

9 " "

ON OFF

ON OFF

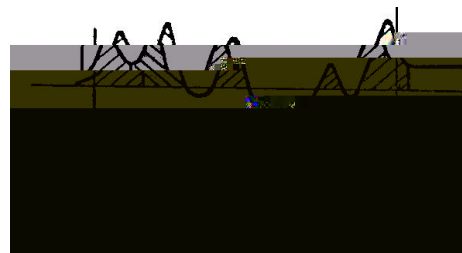
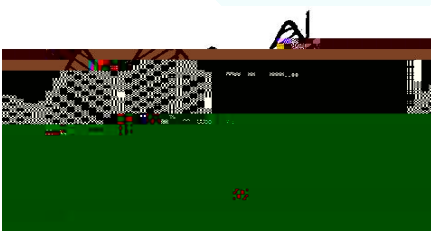
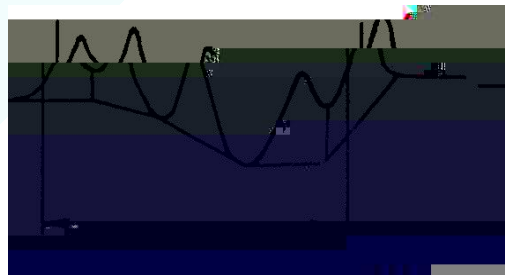

225

027-83267669

赫兹电力
HERTZ POWER



6

6 1

6 2

FID

6 3

6 3 1

(50mm)

(4mm)

6.1

6.1



赫兹电力
HERTZ POWER

产品宗旨：技术创新，质量可靠，服务周到
服务宗旨：快速响应，达到满意，超过期望

赫兹电力
HERTZ POWER





6.2 :

6 4

260

24

5A

5A

6 5

260

24

5A

5A

7

7 1

7 1 1

7 1 2

IP	IP
	IP



7 2

7 2 1

	20 /

7 2

赫兹电力
HERTZ POWER

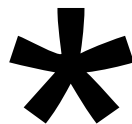
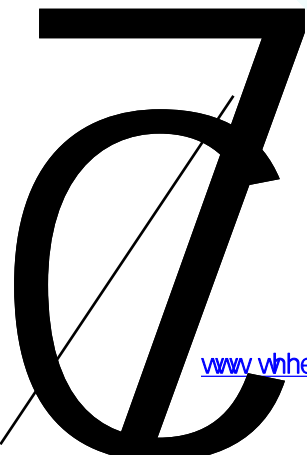
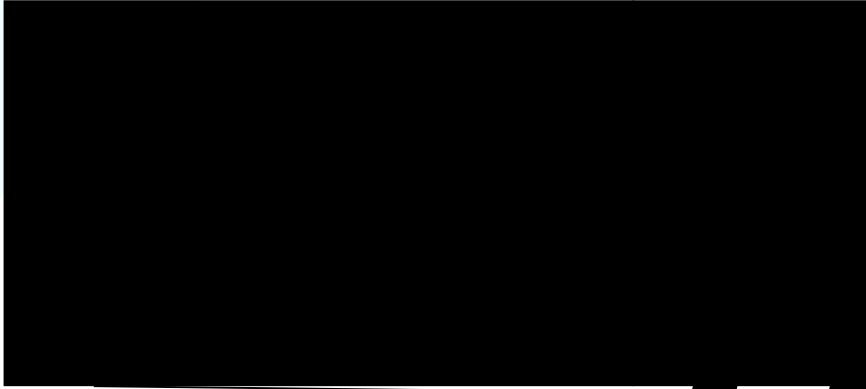



7 2 5

7 2 6

7 2 7

7 2 8



赫兹电力
HERTZ POWER

产品宗旨：技术创新，品质卓越，服务宗旨：快速响应，达到满意，超过期望

7 2 9

赫兹电力
HERTZ POWER





7 2 13

7 2 14

7 2 15

7 2 16



赫兹电力
HERTZ POWER

产品宗旨：技术创新，质量可靠，服务周到
服务宗旨：快速响应，达到满意，超过期望



赫兹电力
HERTZ POWER



--	--

7 2 21

7 2 22

7 2 23

	FID

7 2 24



8

8.1

TCD

8.2

8 2 1

TCD	

8 2 2

TCD	

赫兹电力
HERTZ POWER



赫兹电力

HERTZ POWER

产品宗旨：技术领先，质量可靠，服务周到
服务宗旨：快速响应，达到满意，超过期望

赫兹电力
HERTZ POWER





- 1.
- 2.
- 3. —
- 4.

赫兹电力
HERTZ POWER





HZSP

"

"

"

"

HZSP

- 1
- 2
- 3
- 4
- 5

- 1
- 2
- 3



赫兹电力
HERTZ POWER

— N—G
N—G N—G

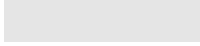

·
·
·



赫兹电力
HERTZ POWER



1
2

1.

2.

1
2

3

027-83267669

4

2

24

24

48