

<N 5! J





HZFA-V



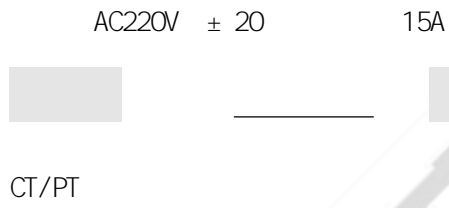

PT

CT

PT

/

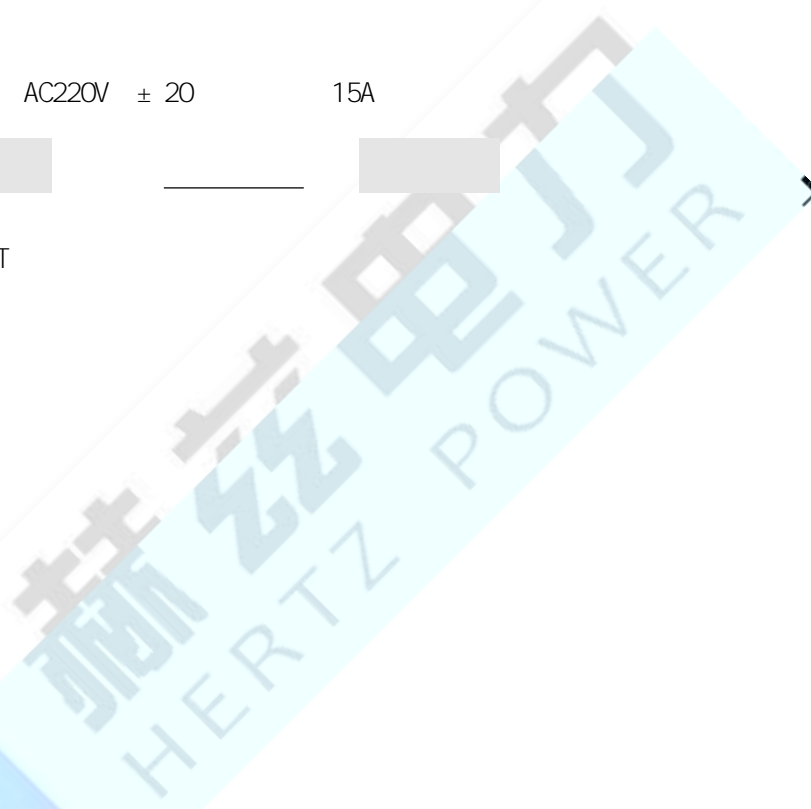

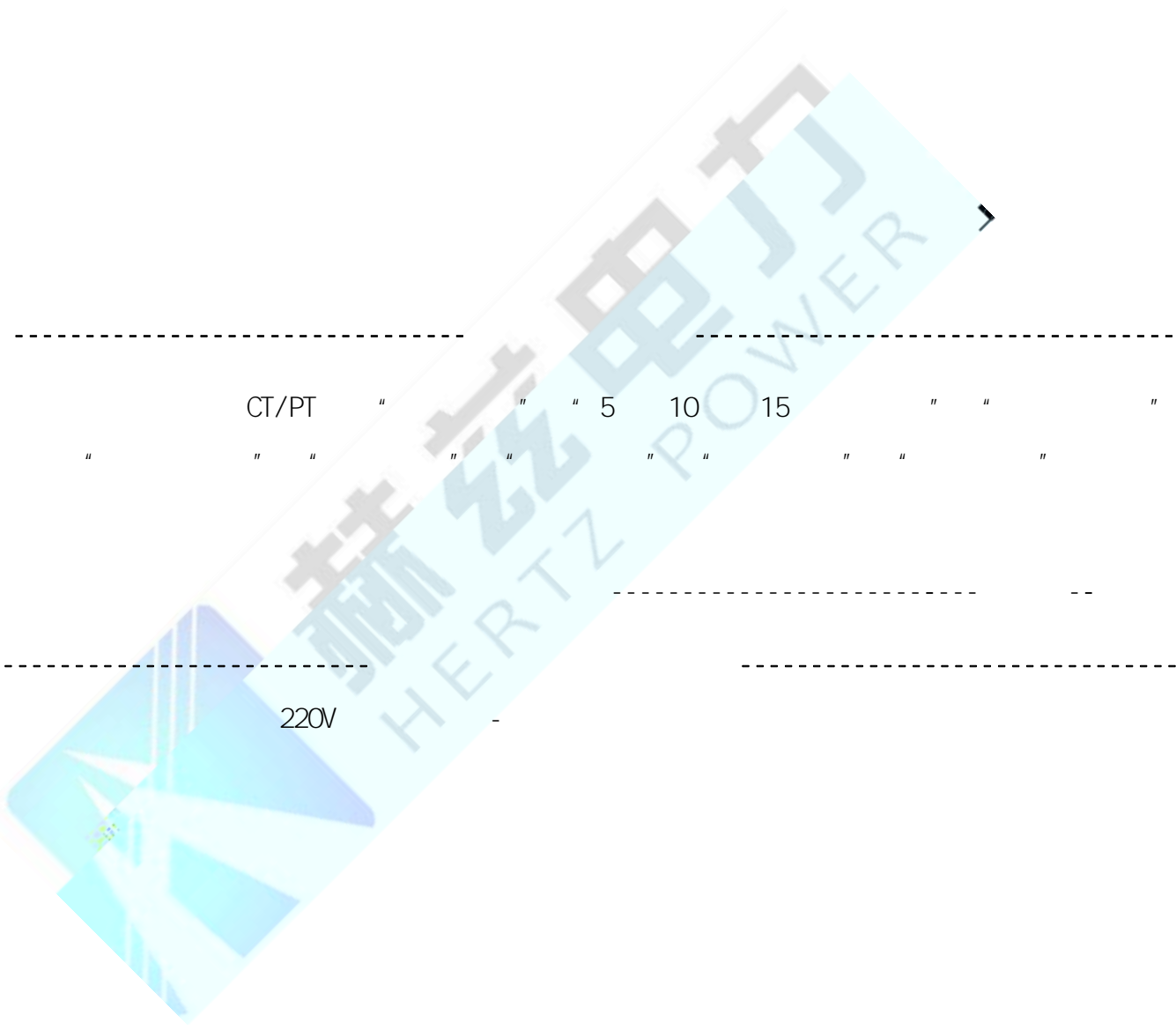
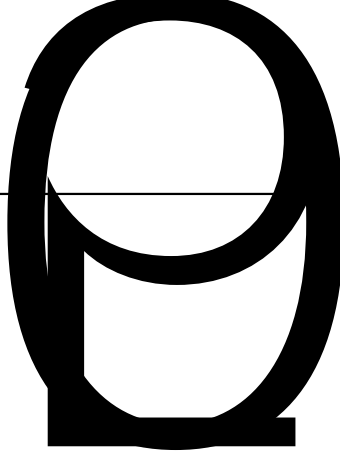

CT/PT " " " 5 10 15 " " "

" " " " " " " " " "

220V

2000

RS232

U

20Kg

CT	220V	0—1000V	3KVA	< 0.5%
PT	220V	0—330V	3KVA	< 0.5%
CT	220V	0-8V		< 0.5%
PT	220V	0—1000V		< 0.5%
CT	-			



220V

CT PT U

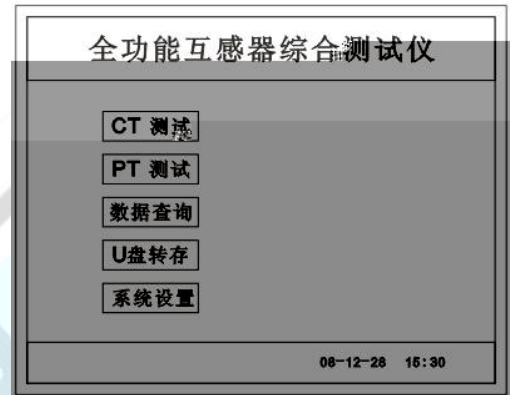

A.



CT



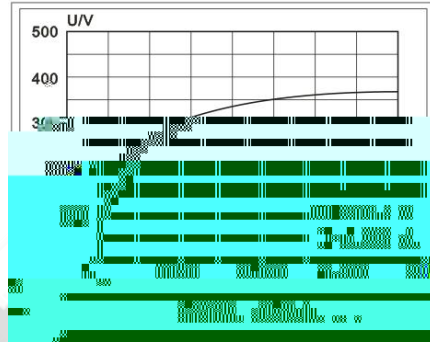
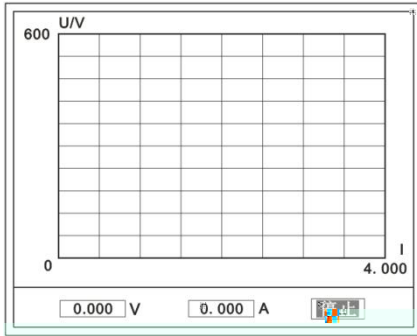
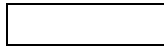

d.



()

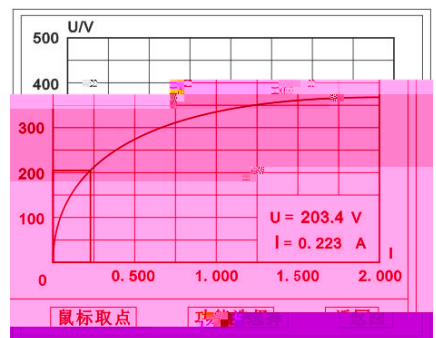



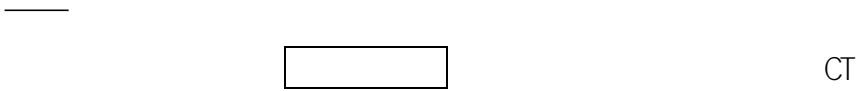

b.



c.

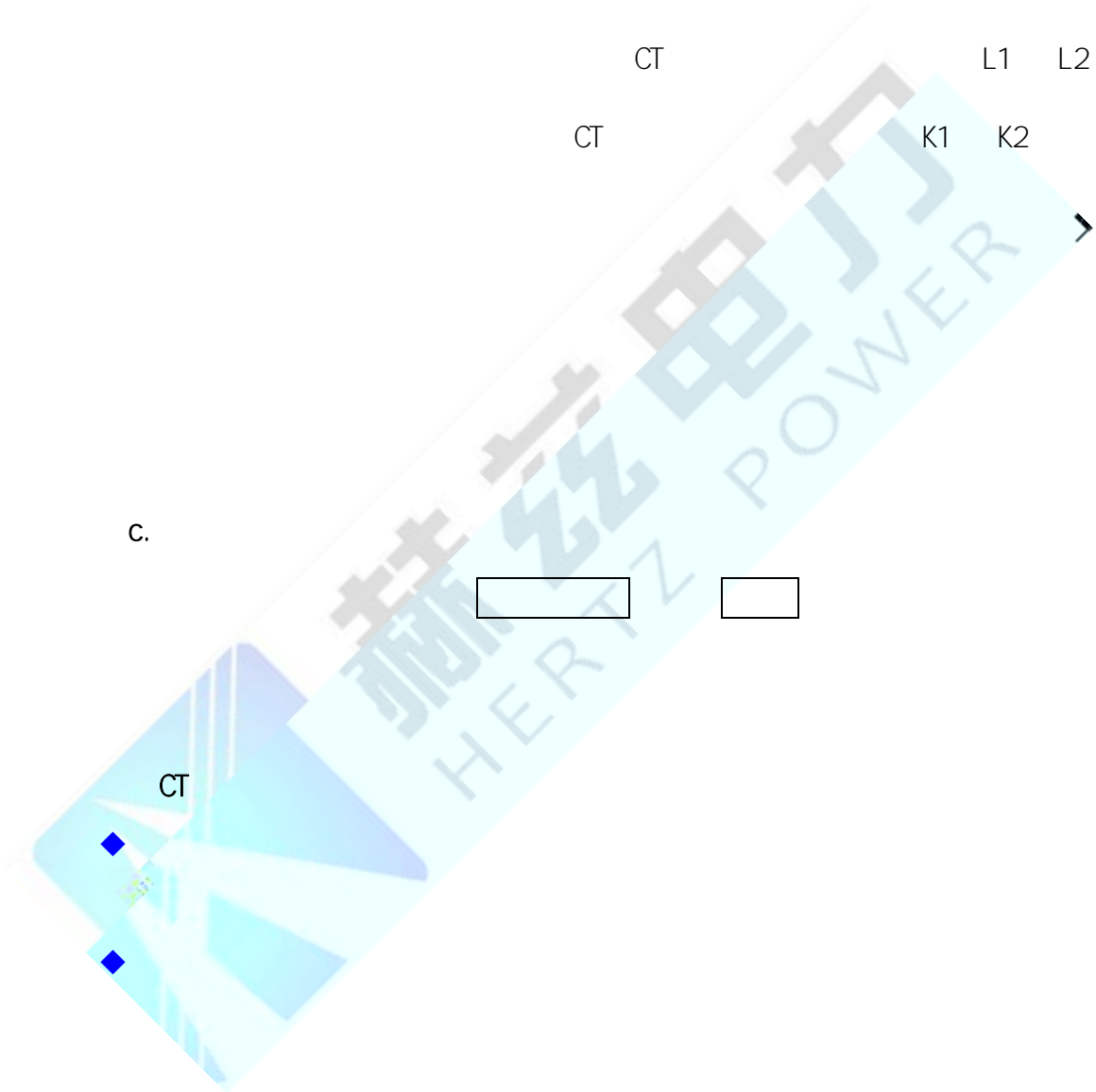



e.

5

200A

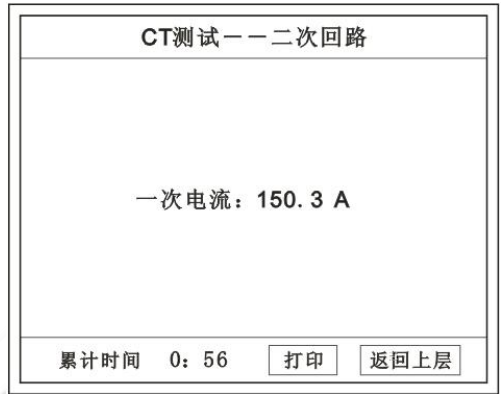

E.

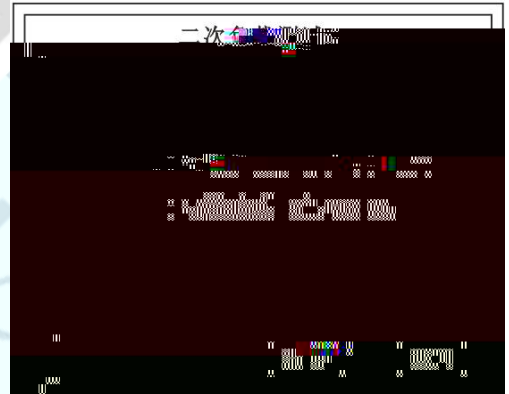

4. PT

PT

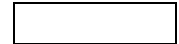
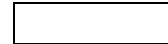

PT

PT

CT

CT

A. PT



PT

PT

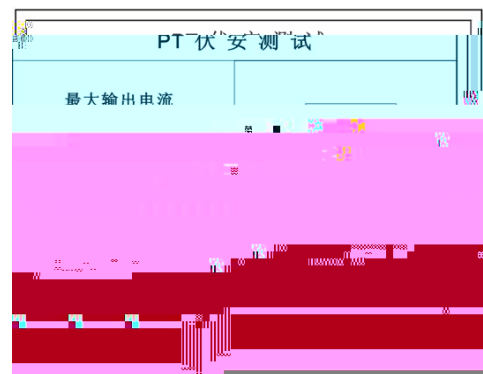
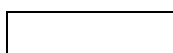

a.



0 - 3 A



0~330V



b.



B. PT

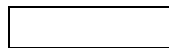
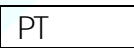

a.



0 - 1000



5

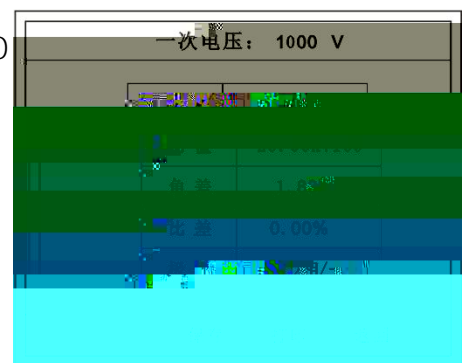

b.



PT

a x

c.

5

1000V



5.

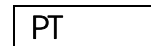
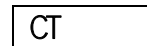

A. CT

a.

b.

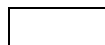
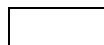
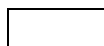

N	编号	相序	Kn	时间	类型
1	ABC001	A		09-05-01-15:23	变比
2	ABC001	A	1	09-05-01-15:23	变比
3	ABC001	A	1	09-05-01-15:23	伏安
4	ABC001	A	2	09-05-01-15:23	伏安

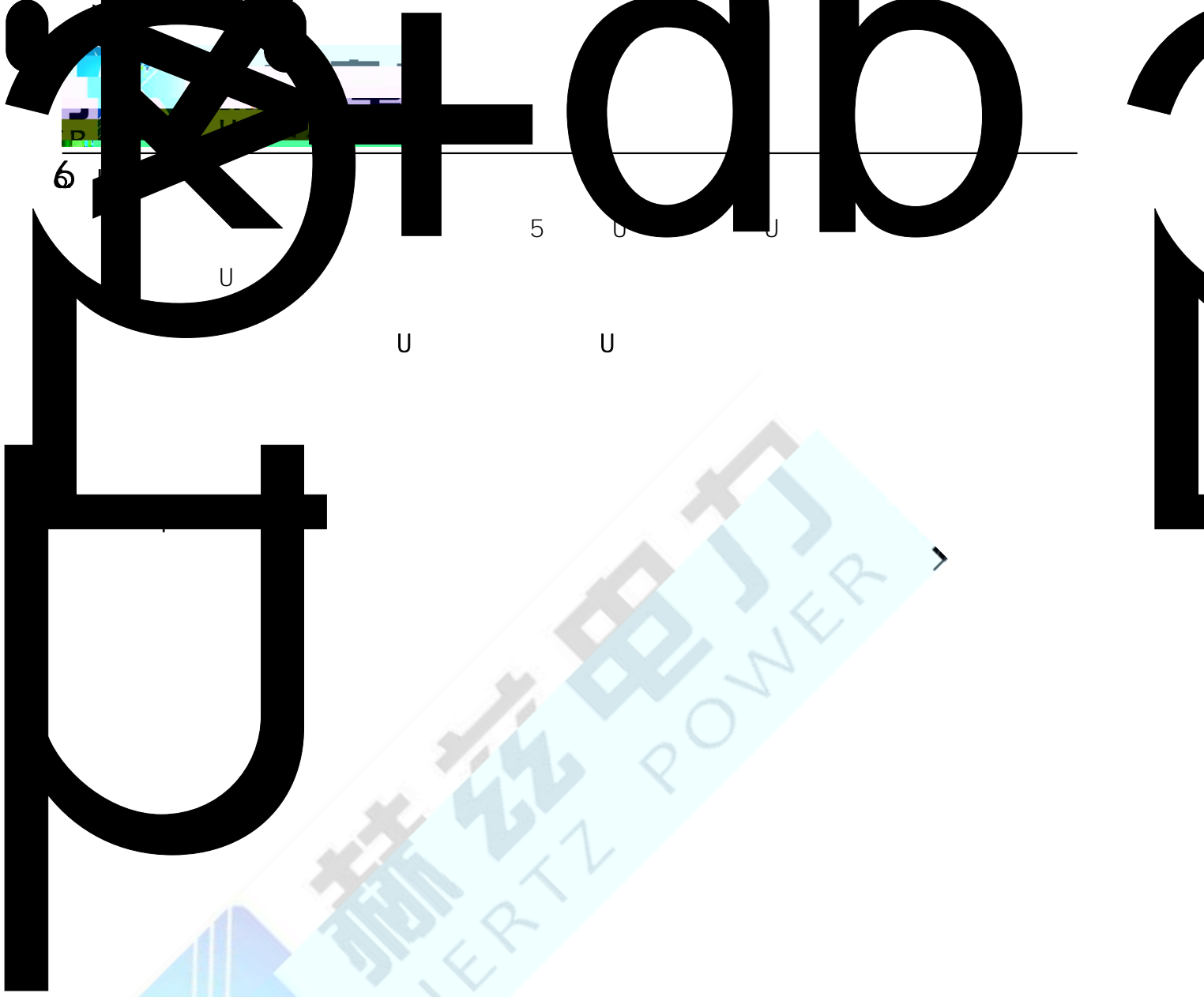



赫兹电力
HERTZ POWER

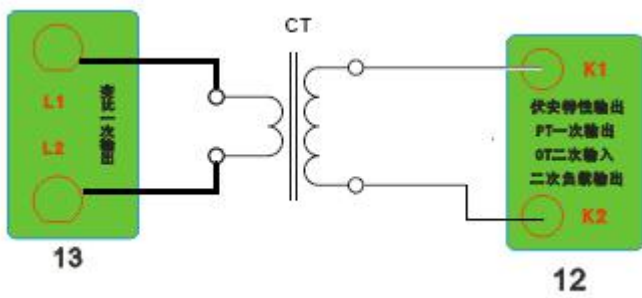
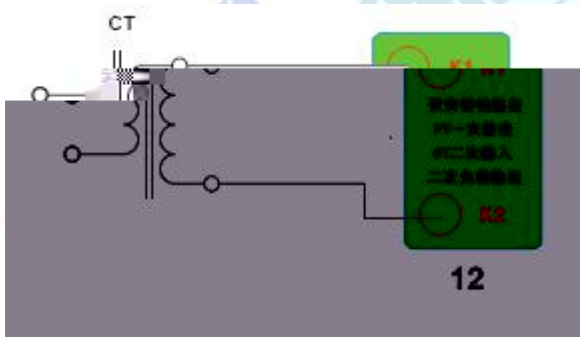

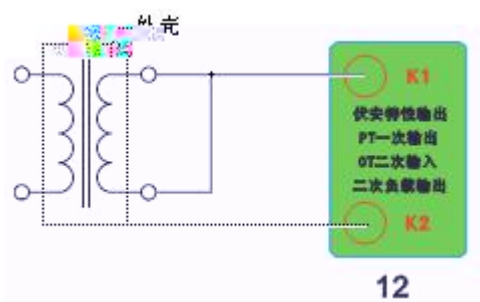
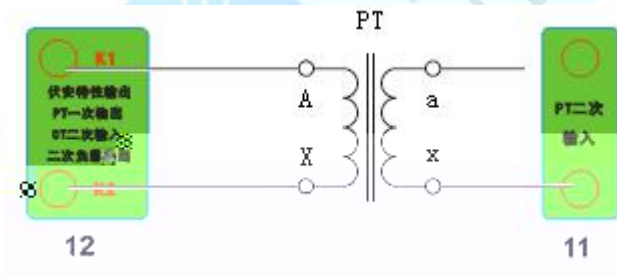
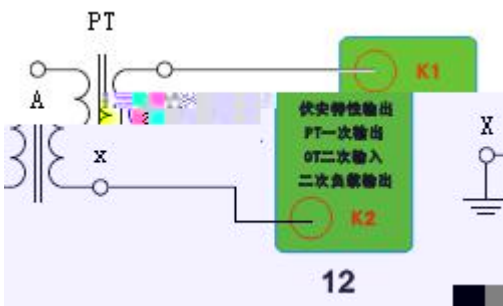
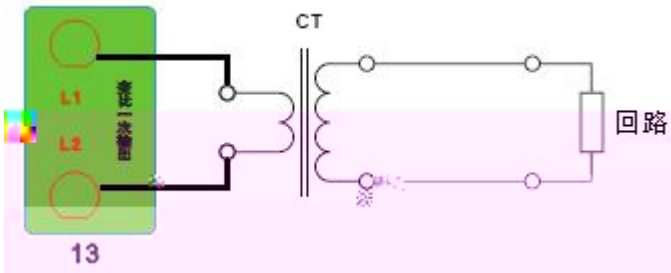

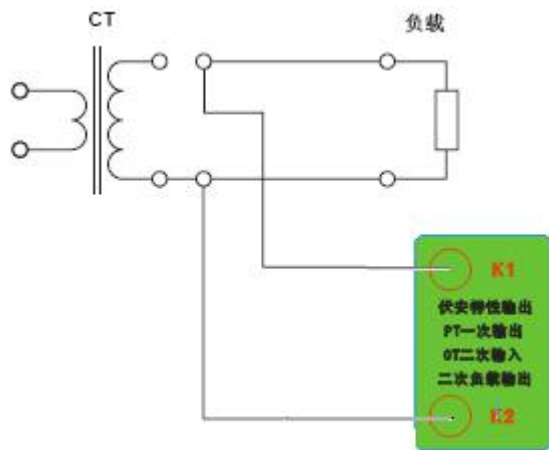
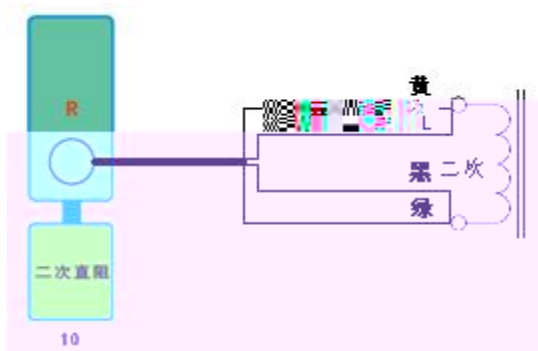



"

"

"

"

1

2

1.

2

1

2

3

2

24

027-83267669

24

48

4